



**Gas Zero Turn Radius Lawn Mower
Operators' Manual**

Model: MNA152502

2018

Daye North America, Inc.
3400 Saint Vardell Lane
Suite D
Charlotte, NC 28217

Customer Service: 855-790-9771

⚠ WARNING :

For your own safety please read this manual before attempting to operate your new unit. Failure to follow instructions can result in serious personal injury. Spend a few moments to familiarize yourself with your mower before each use. Keep this manual in a safe place so that the information is available at all times. If you give the equipment to any other person, hand over these operating instructions and safety regulations as well.

Intended use

The equipment may only be used for the tasks it is designed to handle. Any other use is deemed to be a case of misuse. The user/operator and not the manufacturer will be liable for any damage or injuries of any kind caused as a result of this.

The gasoline lawn mower is intended for private use i.e. for use in home and garden environments.

Private use of the lawn mower refers an annual operating time generally not exceeding that of 50 hours, during which time the machine is primarily used to maintain small-scale, residential lawns and home/hobby gardens. Public facilities, sports facilities, and agricultural/forestry applications are excluded.

Please note that our equipment has not been designed for use in commercial, trade or industrial applications. Our warranty will be voided if the machine is used in commercial, trade or industrial businesses or for equivalent purposes.

The operating instructions as supplied by the manufacturer must be kept and referred to in order to ensure that the lawn mower is properly used and maintained. The instructions contain valuable information on operating, maintenance and servicing conditions.

Important! Due to the high risk of bodily injury to the user, the lawn mower may not be used to trim bushes, hedges or shrubs, to cut scaling vegetation, planted roofs, or balcony-grown grass, to clean (suck up) dirt and debris off walkways, or to chop up tree or hedge clippings. Moreover, the lawn mower may not be used to level out raised mounds of soil.

For safety reasons, the lawn mower may not be used as a drive unit for other work tools or toolkits of any kind.

CONTENTS

SECTION 1	SYMBOLS MARKED ON THE PRODUCT.....	3
SECTION 2	GENERAL SAFETY RULES.....	4
SECTION 3	PARTS DESCRIPTION.....	6
SECTION 4	TECHNICAL DATA.....	6
SECTION 5	ASSEMBLY.....	7
SECTION 6	3 IN 1 DISCHARGE CONFIGURATION.....	9
SECTION 7	OPERATION INSTRUCTIONS.....	11
SECTION 8	MAINTENANCE INSTRUCTIONS.....	15
SECTION 9	LUBRICATION INSTRUCTIONS.....	15
SECTION 10	CLEANING.....	15
SECTION 11	OFF SEASON STORAGE INSTRUCTIONS.....	18
SECTION 12	TROUBLESHOOTING	20
SECTION 13	WARRANTY.....	21
SECTION 14	DISPOSAL.....	21

⚠ WARNING :

For your own safety please read this manual before attempting to operate your new unit. Failure to follow instructions can result in serious personal injury. Spend a few moments to familiarize yourself with your mower before each use.

1. SYMBOLS MARKED ON THE PRODUCT (ON THE REAR COVER)



Fig. A

- B.1 Read Operator's Manual.
- B.2 Keep Bystanders Away.
- B.3 Do not put hands or feet under rotating parts.
- B.4 Fuel is flammable. Do not add fuel to a running machine.
- B.5 Toxic fumes; don't operate inside house.
- B.6 When mowing, please wear protective safety glasses and ear plugs.
- B.7 Remove the spark plug before attempting any repairs. Refer to owner's manual when making repairs.
- B.8 Caution: Engine is hot. To avoid burns, do not touch hot engine.



Figure B: Safety Label Found On Lawn Mower: **KEEP HANDS AND FEET AWAY FROM MOVING PARTS.**

Warning: Keep the safety labels clear and visible on the equipment. Replace the safety labels if they are missing or illegible.

2. GENERAL SAFETY RULES

⚠ WARNING: When using gas tools, read, understand and follow all instructions on the machine and in the manual(s) before starting. Be thoroughly familiar with the controls and the proper use of the machine before starting.

⚠ WARNING: This machine produces an electromagnetic field during operation. This field may, under some circumstances, interfere with active or passive medical implants. To reduce the risk of serious or fatal injury, we recommend persons with medical implants to consult their physician and the medical implant manufacturer before operating this machine.

Training

- Never allow children or people unfamiliar with these instructions to use the lawn mower. Local regulations can restrict the age of the operator;
- Never mow while people, especially children, or pets are nearby;
- Keep in mind that the operator or user is responsible for accidents or hazards occurring to other people or their property.
- The operators must receive proper training in the use, adjustment and operation of the machine, including prohibited operations.

Preparation

- While mowing, always wear proper footwear and long pants. Do not operate the equipment when barefoot or wearing open sandals;
- Thoroughly inspect the area where the equipment is to be used and remove all objects, such as stones, toys, sticks and wires, which can be thrown by the machine;
- **WARNING-** Gasoline is highly flammable.
 - Store fuel in a container specifically designed for this purpose;
 - Refuel outdoors only and do not smoke while refueling;
 - Add fuel before starting the engine. Never remove the cap of the fuel tank or add gasoline while the engine is running or when the engine is hot;
 - If gasoline is spilled, do not attempt to start the engine. Move the machine away from the area of spillage and avoid creating any source of ignition until gasoline vapors have dissipated;
 - Replace all fuel tank and container caps securely;
- Replace faulty silencers;
- Before using, always visually inspect to see that the blades, blade bolts and cutter assembly are not worn or damaged. Replace worn or damaged blades and bolts in sets to preserve balance. The operator can purchase replacement silencers, blades and bolts from DAYE North America.

Operation

- Do not operate the engine in a confined space where dangerous carbon monoxide fumes can collect;
- **Warning!** Do not use the lawnmower when there is a risk for lighting.
- It is recommended to limit the duration of operation, in order to minimize the risks from noise and vibration.
- Be careful when using the lawnmower in slopes and near drop-offs, ditches or embankments.
- Mow only in daylight or in good artificial light;
- Avoid operating the equipment in wet grass,
- Always be sure of your footing on slopes;

- Walk, never run while operating the lawnmower
- Mow across the face of slopes, never up and down;
- Exercise extreme caution when changing direction on slopes;
- Do not mow excessively steep slopes;
- Use extreme caution when reversing or pulling the lawn mower towards you. Always look down and behind before and while moving backwards.
- Stop the blade(s) when crossing gravel drives, walks, or roads.
- Never operate the lawn mower with defective guards, or without safety devices such as deflectors and/or grass catchers, in place;
- Caution: The lawnmower shall not be operated without either the entire grass catcher or self-closing discharge opening guard in place.
- Do not change the engine governor settings or cause the engine to run at an excessive speed;
- Do not alter or tamper with any sealed adjustment for the engine speed control.
- Do not disable the lawnmower safety systems.
- Disengage all blades and drive clutches before starting the engine;
- Start the engine carefully according to instructions and with feet well away from the blade(s);
- Do not tilt the lawn mower when starting the engine;
- Do not start the engine when standing in front of the discharge chute;
- Do not put hands or feet near or under rotating parts. Keep clear of the discharge opening at all times;
- Never pick up or carry a lawn mower while the engine is running;
- Stop the engine and disconnect the spark plug wire, make sure that all moving parts have come to a complete stop and, where a key is fitted, remove the key before doing the following:
 - Before clearing blockages or unclogging chute;
 - Before checking, cleaning or working on the lawn mower;
 - After striking a foreign object. Inspect the lawnmower for damage and make repairs before restarting and operating the lawn mower;
 - If lawn mower starts to vibrate abnormally (check immediately);
 - Whenever you leave the mower;
 - Before refueling.
- Reduce the throttle setting during engine shut down and, if the engine is provided with a shut-off valve, turn the fuel off at the conclusion of mowing.

Maintenance and storage

- Keep all nuts, bolts and screws tight to be sure the equipment is in safe working condition;
- Never store the equipment with gasoline in the tank inside a building where fumes can reach an open flame or spark;
- Allow the engine to cool before storing in any enclosure; Clean and maintain the lawnmower before storage.
- To reduce fire hazard, keep the engine, silencer, battery compartment and gasoline tank free of grass, leaves, or excessive grease;
- Check the grass catcher frequently for wear or deterioration;
- Replace worn or damaged parts for safety;
- If the fuel tank has to be drained, this should be done outdoors.
- Improper maintenance, use of non-conforming replacement components, or the removal or modification of safety components can damage the lawnmower and injure the operators seriously.
- Only use the recommended blades and spare parts by the manufacturer. The use of

non-genuine parts can damage the machine and injure the operators. Keep the lawnmower in good working condition.

- If the brake control handle doesn't work, please contact service center for help. For service center near you go to www.mowoxusa.com

WARNING: Do not touch rotating blade.

WARNING: Refuel in a well-ventilated area with the engine stopped.

3. PARTS DESCRIPTION

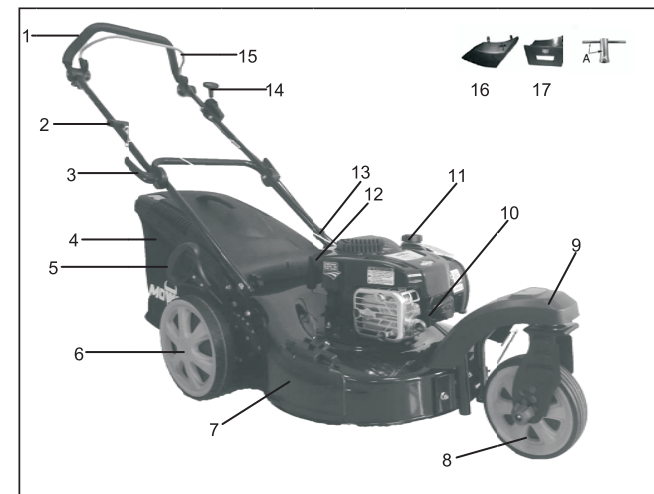

Fig.1

- | | | | |
|------------------------------|--------------------|--------------------------|-----------------------|
| 1. Upper handle | 2. Starter handle | 3. Locking lever | 4. Grass catcher |
| 5. Height adjusting lever | 6. Wheel | 7. Sideward flap | 8. Front caster wheel |
| 9. Front caster wheel holder | 10. Spark Plug | 11. Fuel cap | 12. Oil cap |
| 13. Cable clamp | 14. Locking handle | 15. Brake control handle | |
| 16. Side discharge channel | 17. Mulching wedge | | |

Including: A: Spark plug wrench

4. TECHNICAL DATA

Model	MNA152502
Engine type	B&S 625EXi
Engine Displacement	150cm ³
Nominal Power	2.5kW
Blade Width	20 in.

Rated Speed	2800/min
Oil Capacity	0.47L
Grass catcher capacity	60L
Net Weight	64.5 lb.
Height adjustment	1" to 3", 6 adjustment

5. ASSEMBLY

5.1 ASSEMBLE FOLDING HANDLE

1. Fix the lower handlebars into the unit body with bolts, washers and locking knobs. (Fig. 2A /Fig.2B)
2. Lift the two locking levers to release the upper handlebars for folding. (Fig.2C)
3. Push the locking lever closed to lock the handlebars in the operating position. (Fig.2D)
4. Adjust the tension by turning the locking nut with a suitable spanner. (Fig.2E)
5. Attach the cable-clamp to the position shown and then attach the cable. (Fig.2F)

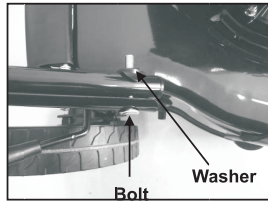

Fig.2A

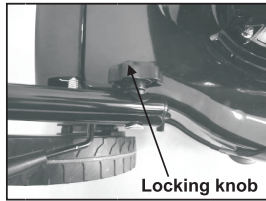

Fig.2B

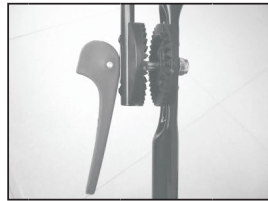

Fig.2C

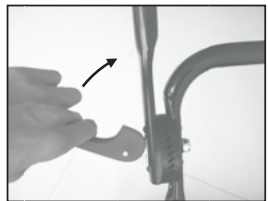

Fig.2D

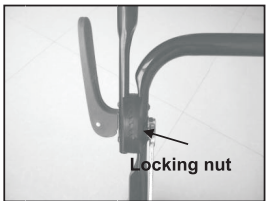

Fig.2E

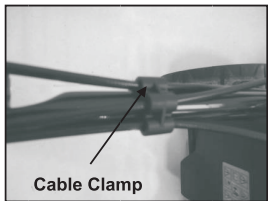

Fig.2F

5.2 ADJUSTMENT FOR AN APPROPRIATE ANGLE

1. Pull the locking lever opening;
2. Rotating the upper handle centered of the angle adjusting gear for adjusted appropriate angle into the scope -20° to 20° as the Fig.3 shown;
3. Push the locking lever closed to connect the lower handle and the upper handle.

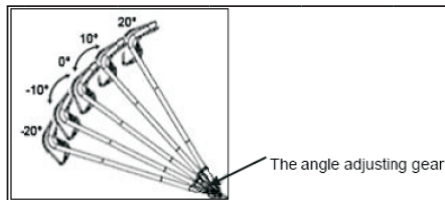

Fig.3

5.3 ASSEMBLE FRONT CASTER WHEEL HOLDER

1. Fix the front caster wheel holder into the deck body with three hexagon bolts and hexagon locking nuts, adjust the tension by turning the locking nut with a suitable spanner (Fig. 4A /Fig.4B)
2. Attach the cable-clamp on the deck to the position shown and then attach the cable. (Fig.4C)

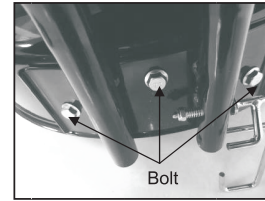

Fig.4A

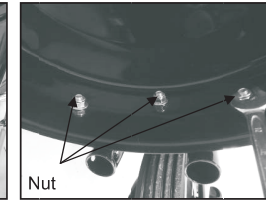

Fig.4B

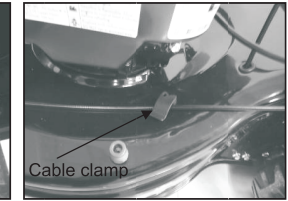

Fig.4C

5.4 MOUNTING AND DISMOUNTING THE GRASS CATCHER

1. To fit: Raise the rear cover and hitch the grass catcher on rear of mower. (Fig.5A/Fig.5B/Fig.5C)
2. To remove: grasp and lift rear cover, remove grass catcher.

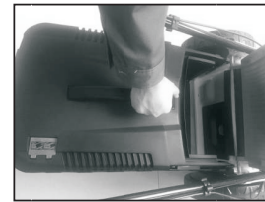

Fig.5A



Fig.5B



Fig.5C

5.5 STARTER HANDLE

Move the starter handle from the engine to the rope guide. (Fig.6A/Fig.6B)

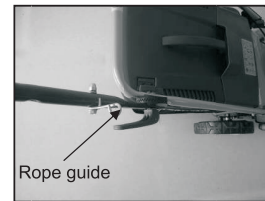

Fig.6A

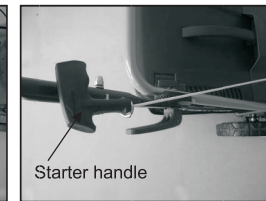

Fig.6B

5.6 ADJUSTING THE HEIGHT OF CUT

The rear wheels can be adjusted by the height adjustment lever by applying outward pressure on the lever to disengage it from the rack. Move lever forward or back to adjust height. (From 1" to 3") (Fig.7A)

The front caster wheel is also equipped with a height adjusting system which can adjust 6 levels. (From 1" to 3") (Fig.7B/Fig.7C)

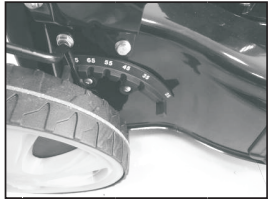

Fig. 7A



Fig. 7B

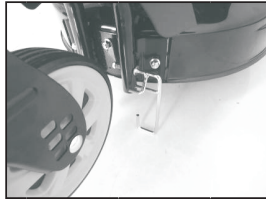

Fig. 7C

6. 3 IN 1 DISCHARGE CONFIGURATION

This lawnmower can be used any one of three ways. :

1. Mulching mower
2. Side-discharge mower
3. Rear Bagging

What is mulching?

When mulching, the grass is cut and finely chopped and returned to the grass strip as natural fertilizer.

Hints for mulch-mowing:

- Cut your grass more often and try to cut less than 1" when the grass is between 1.5" and 3" tall.
- Make sure your blade is sharp and do not mulch when grass is wet
- Set to maximum engine speed.
- Mow at a slower pace.
- Regularly clean mulching wedge, housing and mower blade.

Starting Operation

ONE: Reconfiguring for mulching mower

⚠ WARNING: Only when mower is completely shut off!

1. Raise the rear cover and remove the grass catcher.
2. Push the mulching wedge into the deck. Lock the mulching wedge with the button into the opening on the deck. (Fig.8A/Fig.8B)
3. Lower the rear cover again. (Fig.8C)

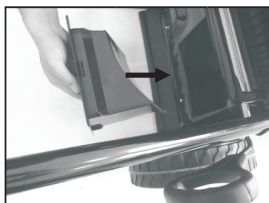

Fig.8A

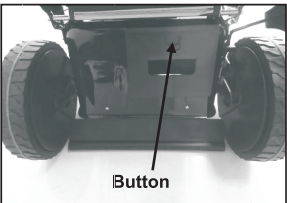

Fig.8B

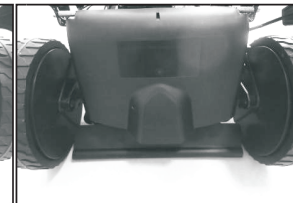

Fig.8C

TWO: Reconfiguring for side-discharge mowing

⚠ WARNING: Only when mower is completely shut off!

1. Lift the rear cover and remove the grass catcher.
2. Mount the Mulching wedge.
3. Unlock the locking mechanism. (Fig. 9A)
4. Lift sideward flap for side discharge. (Fig. 9B)
5. Mount the side discharge channel for side discharge on the support pin of the sideward flap. (Fig.9C)
6. Lower the sideward flap- the flap lies on the side discharge channel. (Fig.9D)

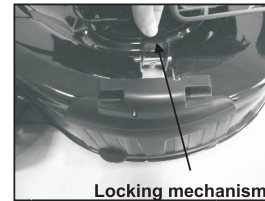

Fig.9A



Fig.9B



Fig.9C



Fig.9D

THREE: Mowing with the grass catcher

⚠ WARNING: Only when mower is completely shut off!

For mowing with the grass catcher, remove the mulching wedge and discharge channel for side discharge and mount the grass catcher.

1. Removing the mulching wedge:
 - Lift rear cover and remove the mulching wedge.
2. Removing the side discharge channel for side discharge:
 - Lift sideward flap and remove the side discharge channel.
 - The sideward flap automatically closes the discharge opening on the housing by mean of spring force.
 - Regularly clean the sideward flap and discharge opening forms of grass rest and stuck dirt.
3. Mount the grass catcher:
 - To fit: Raise the rear cover and hitch the grass catcher on rear of mower.
 - To remove: Grasp and lift the rear cover, remove grass catcher.

7. OPERATING INSTRUCTIONS

7.1 BEFORE STARTING

Service the engine with gasoline and oil as instructed in the separate engine manual packed in your mower. Read instructions carefully.

⚠ WARNING! Gasoline is highly flammable.

Store fuel in containers specifically designed to hold gasoline.

Refuel outdoors only, before starting the engine and do not smoke while refueling or handling fuel.

Never remove the cap of the fuel tank or add gasoline while the engine is running or when the engine is hot.

If gasoline is spilled, do not attempt to start the engine. Move the machine away from the area of spillage and avoid creating any source of ignition until gasoline vapors have dissipated.

Replace all fuel tanks and container caps securely.

Before tipping the lawn mower to maintain the blade or drain oil, remove fuel from tank.

⚠ WARNING: Never fill fuel tank indoors, with engine running or until the engine has been allowed to cool for at least 15 minutes after running.

7.2 TO START ENGINE AND ENGAGE BLADE

1. The unit is equipped with a rubber cover over the end of the spark plug, make certain the metal loop on the end of the spark plug wire (inside the rubber cover) is fastened securely over the metal tip on the spark plug.
2. Standing behind the unit, grasp the brake control handle and hold it against the upper handle as shown in Fig. 10
3. Grasp the starter handle as shown Fig.10 and pull up rapidly. Return it slowly to the rope guide bolt after engine starts. Release the brake control handle to stop the engine and blade.



Fig.10

⚠ Start the engine carefully according to instructions and with feet well away from the blade.

⚠ Do not tilt the lawn mower when starting the engine. Start the mower on a level surface, free of high grass or obstacles.

⚠ Keep hands and feet away from the rotating parts. Do not start the engine when standing in front of the discharge opening.

7.3 OPERATION PROCEDURES

During operation, tightly hold the brake handle with both hands.

Note: During operation, when the brake handle is released, the engine will stop and thus stopping the lawnmower from operating.



Note: Switch the locking handle to unlock”  position and the front caster wheel will turn around freely. (Fig.11A). Switch the locking handle to lock”  position and the front caster wheel will keep straight. (Fig.11B)



Fig.11A

Fig.11B

⚠ WARNING: In order to avoid any unintentional start-ups of the lawn mower, it comes equipped with an engine brake which must be pulled back before the engine can be started. When the engine control lever is released it must return to its initial position, at which point the engine automatically switches off.

Note: Engine brake (brake handle): Use the lever to stop the engine. When you release the lever the engine and the blade stop automatically. To mow, hold the lever in the working position. Before you start to mow, check the start/stop lever several times to be sure that it is working properly. Ensure that the tension cable can be smoothly operated (i.e. is not catching or kinking in any way)

7.4 TO STOP ENGINE

⚠ CAUTION: The blade continues to rotate for a few seconds after the engine is shut off.

1. Release the brake control handle to stop the engine and blade. (Fig.12)
2. Disconnect and ground the spark plug wire as instructed in the separate engine manual to prevent accidental starting while equipment is unattended.

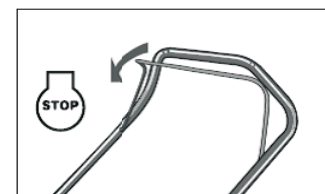

Fig.12

7.5 FOR THE BEST RESULTS WHEN MOWING

Clear lawn of debris prior to mowing. Be sure that the lawn is clear of stones, sticks, wire or other foreign objects which could be accidentally thrown out by the mower in any direction and cause serious personal injury to the operator and others as well as damage to property and surrounding objects. For effective mowing do not cut wet grass because it tends to stick to the underside of the deck preventing proper mowing of the grass clippings. Cut no more than 1/3 the length of the grass. The recommended cut for mowing is 1/3 the length of the grass. Ground speed will need to be adjusted so the clippings can be dispersed evenly into the lawn. For especially heavy cutting in thick grass it may be necessary to use one of the slowest speeds in order to get a clean, well-mowed cut. When mowing long grass you may have to cut the lawn in two passes, lowering the blade another 1/3 of the length for the second cut and perhaps cutting in a different pattern than was used the first time. Overlapping the cut a little on each pass will also help to clean up any stray clippings left on the lawn. The mower should always be operated at full throttle to get the best cut and allow it to do the most effective job of mowing. Clean underside of deck. Be certain to clean the underside of the cutting deck after each use to avoid a build-up of grass, which would prevent proper mulching. The mowing of leaves can also be beneficial to your lawn. When mowing leaves make sure they are dry and are not laying too thick on the lawn. Do not wait for all the leaves to be off the trees before you mow.

⚠ WARNING: If you strike a foreign object, stop the engine. Remove wire from spark plug, thoroughly inspect the mower for any damage and repair the damage before restarting and operating the mower. Extensive vibration of the mower during operation is an indication of damage. The unit should be promptly inspected and repaired.

7.6 GRASS CATCHER

There is a level indicator on the top of the grass catcher that shows whether the catcher is empty or full :

- The level indicator remains open if the grass catcher is not full. (Fig. 13A)
- If the grass catcher is full, the indicator collapses; once this happens, stop moving immediately and empty the catcher, make sure it is clean and ensure its meshwork is ventilated. (Fig. 13B)

⚠ IMPORTANT:

If the position of indicator opening is very dirty, the indicator will not open. In this case, clean the position of indicator opening immediately.

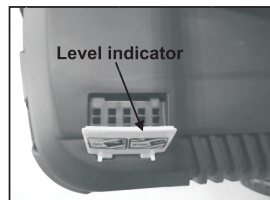

Fig. 13A

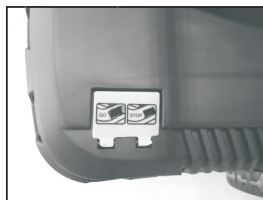

Fig. 13B

7.7 HEIGHT ADJUSTMENT INSTRUCTIONS

⚠ CAUTION: Do not at any time make any adjustment to lawnmower without first stopping the engine and disconnecting the spark plug wire.

⚠ CAUTION: Before changing mowing height, stop mower and disconnect spark plug cable.

Your mower is equipped with a central height adjustment lever offering 6 height positions.

The height (the blade to the ground) can be adjusted from 1" to 3" (6 height positions). (Fig.14)

1. Stop mower and disconnect spark plug cable before changing mower cutting height.
2. The central height adjustment lever offers you 6 different height positions.

For rear wheel:

To change the height of rear wheel, squeeze adjuster lever toward the wheel, moving up or down to selected height.

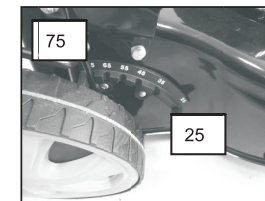

Fig.14

For front caster wheel:

It's equipped with a 6 levers height adjusting system. (From 25mm to 75mm) Fig.15A

- 1) Lift front caster wheel holder a little bit, pull out the support lever and meanwhile rotate counterclockwise (Fig.15B)
- 2) Fix the support lever into the holder body, make sure the support lever is located in position. (Fig.15C)
- 3) To change the height of front wheel, adjust height adjusting knob and height adjusting bolt to choose the suitable height, and assemble front caster wheel as shown in Fig.15D. The assembled front caster wheel as shown in Fig.15E



Fig.15A

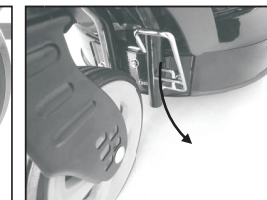

Fig.15B

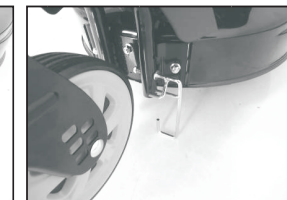

Fig.15C

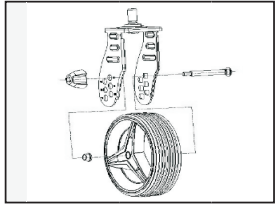

Fig. 15D

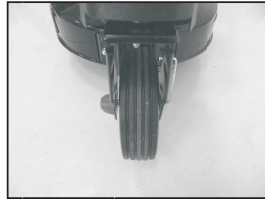

Fig. 15E

⚠ CAUTION: Remember the cutting height of front caster wheel should be the same height as rear wheel.

8. MAINTENANCE INSTRUCTIONS

SPARK PLUG

Use only original replacement spark plug. For best results, replace the spark plug every 100 hours of use.

BRAKE PADS

Check and/or replace the engine brake pads in service agent regularly, only original parts can be used as replacement.

9. LUBRICATION INSTRUCTIONS

⚠ CAUTION: DISCONNECT SPARK PLUG BEFORE SERVICING.

1. WHEELS-Lubricate the ball bearings in each wheel at least once a season with a light oil, such as SAE 10W-30.
2. ENGINE-Follow engine manual for lubrication instructions.

10. CLEANING

⚠ CAUTION: Do not spray the engine with water. Water can damage engine and contaminate the fuel system.

1. Wipe deck with dry cloth.
2. Hose under deck by tilting the mower so that the spark plug is facing away from the water spray.

10.1 ENGINE AIR CLEANER

⚠ CAUTION: Do not allow dirt or dust to clog the air filter foam element. The engine air cleaner element must be serviced (cleaned) after 25 hours of normal mowing. The foam element must be serviced regularly if the mower is used in dry dusty conditions.

To CLEAN AIR FILTER

1. Lift the tab on top of the filter cover. (Fig. 16A)
2. Remove the filter cover. (Fig. 16A)

3. Wash foam filter in soapy water. (Fig. 16B) **DO NOT USE GASOLINE!**
4. Air dry filter element.
5. Place a few drops of SAE30 oil on the foam filter and squeeze tightly to remove any excess oil.
6. Reinstall filter.
7. Close the filter cover.

NOTE: Replace filter if frayed, torn, damaged or unable to be cleaned.

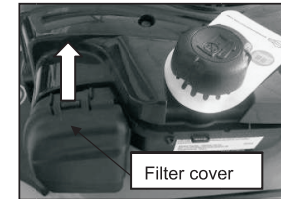

Fig. 16A

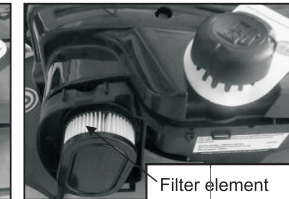

Fig. 16B

10.2 CUTTING BLADE

⚠ CAUTION: Be sure to disconnect and ground the spark plug wire before working on the mower blade to prevent accidental engine starting. Protect hands by using heavy gloves or a rag to grasp the cutting blades. Tip the mower. Remove the hex bolt and washer which hold the blade and blade adapter to the engine crankshaft. Remove the blade and adapter from the crankshaft.

⚠ WARNING: Periodically inspect the blade adapter for cracks, especially if you strike a foreign object. Replace when necessary.

For best results your blade should be sharp. The blade may be resharpened by removing it and either grinding or filing the cutting edge keeping as close to the original bevel as possible. It is extremely important that each cutting edge receives an equal amount of grinding to prevent an unbalanced blade. Improper blade balance will result in excessive vibration causing eventual damage to the engine and mower. Be sure to carefully balance blade after sharpening. The blade can be tested for balance by balancing it on a round shaft screwdriver. Remove metal from the heavy side until it balances evenly.

Before reassembling the blade and the blade adapter to the unit, lubricate the engine crankshaft and the inner surface of the blade adapter with light oil. Insert the key into the blade adapter and install the blade adapter on the engine crankshaft, push the washer into the blade adapter and install the blade, Refer to figure 17. Place the blade with the part number facing away from the adapter. Align the washer over the blade and insert the hex bolt. Tighten the hex bolt to the torque listed below:

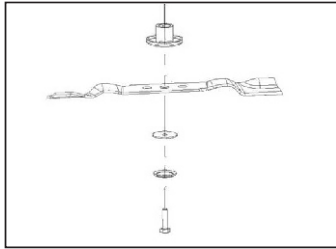

Fig. 17

10.3 BLADE MOUNTING TORQUE

Center Bolt 40Nm-50Nm, to insure safe operation of your unit. ALL nuts and bolts must be checked periodically for correct tightness.

After prolonged use, especially in sandy soil conditions, the blade will become worn and lose some of the original shape. Cutting efficiency will be reduced and the blade should be replaced. Replace with an approved factory replacement blade only. Possible damage resulting from blade unbalance condition is not the responsibility of the manufacturer.

When you change the blade, use the blade marked **DAYE 2105200262**. To order new blades, check with your purchasing retailer or contact your local service dealer. You can also visit mowoxusa.com or call customer service at 855-790-9771.

10.4 ENGINE

Refer to the separate engine manual for engine maintenance instructions.

Maintain engine oil as instructed in the separate engine manual packed with your unit. Read and follow instructions carefully.

Clean every few hours under extremely dusty conditions. Poor engine performance and flooding usually indicates that the air cleaner should be serviced.

To service the air cleaner, refer to the separate engine manual packed with your unit.

The spark plug should be cleaned and the gap reset once a season. Spark plug replacement is recommended at the start of each mowing season; check engine manual for correct plug type and gap specifications.

Clean the engine regularly with a cloth or brush. Keep the cooling system (blower housing area) clean to permit proper air circulation which is essential to engine performance and life. Be certain to remove all grass, dirt and combustible debris from muffler area.

10.5 CLEAN THE DECK AND CUTTING BLADE

⚠ WARNING: Before cleaning, stop mower and disconnect spark plug cable.

⚠ WARNING: The cutting blade continues to rotate for a few seconds after the engine is shut off.

⚠ NOTE: Before cleaning, remove the grass catcher, discharge channel, and / or the mulching wedge.

The blade and deck will be covered with debris after every use, so periodic cleaning is advised.

For the last mow of the season it is recommended that you follow these steps:

⚠ WARNING: Be careful to keep the hose away from going under the deck while the engine is running.

1. Using a water hose, insert the hose connector into the cleaning hole-connector on the deck; ensure they are firmly connected (Fig.18);
2. Connect the other end of the hose to a water tap, and then turn on the water.
3. Connect the spark plug cable, and then start the engine
4. After operating for approximately five minutes, check the deck and blade to ensure they are free of debris. If you still find debris, continue to run water for another few minutes. Once deck and blade are clean, stop the engine, shut off the water and disconnect spark plug cable.
5. After cleaning, take away the hose, and store in a clean and safe place.
6. Wipe the water on the deck and cutter surface, and then lightly grease the cutter to avoid corrosion and rust.

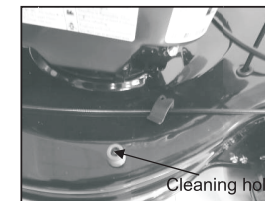

Fig.18

⚠ Start the engine carefully according to instructions and with feet well away from the blade.

⚠ Do not tilt the lawn mower when starting the engine. Start the mower on a level surface, free of high grass or obstacles.

⚠ Keep hands and feet away from the rotating parts. Do not start the engine when standing in front of the discharge opening.

⚠ WARNING: When cleaning, discontinue all other actions, including mowing, mulching etc.

11. STORAGE INSTRUCTIONS (OFF SEASON)

⚠ Warning! Alcohol-blended fuels (called gasohol, ethanol or methanol) can attract moisture which leads to separation and formation of acids during storage. Acidic gas can damage the fuel system of an engine while in storage. To avoid engine problems, the fuel system should be emptied before storage of 30 days or longer. Empty the gas tank, start the engine and let it run until the fuel lines and carburetor are empty. Use fresh fuel next season. The following steps should be taken to prepare lawn mower for storage.

1. Empty the tank after the last mowing of the season.
 - a) Empty the gas tank with a suction pump.

CAUTION! Do not drain the gasoline in closed rooms, in close proximity of open fire, etc. Do not smoke while in close proximity to the mower. Gasoline fumes can cause explosion or fire.

b) Start the engine and let it run until it has stalled, after using up all remaining gasoline in the fuel tank.

c) Remove the spark plug cap by your hand first, and then remove the spark plug by the spark plug wrench (Fig.19A/ Fig.19B/ Fig.19C/ Fig.19D). Use an oil can to fill approx. 20 ml oil into the combustion chamber. Operate the starter to evenly distribute the oil in the combustion chamber. Replace the spark plug.

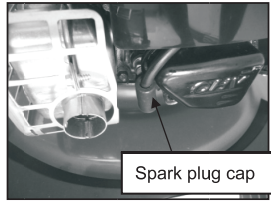

Fig.19A



Fig.19B

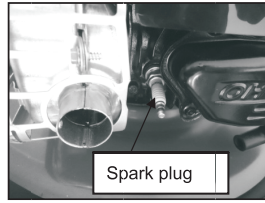

Fig.19C



Fig.19D

2. Clean and grease the lawnmower carefully as described above under "Lubrication".
3. Slightly grease the cutter to avoid corrosion.
4. Store the lawnmower in a dry, clean and frost-protected place, out of reach of unauthorized persons.
5. After use, you should remove the battery pack and check for damage.

CAUTION! The engine must have completely cooled down before storing the lawnmower.

NOTE: - When storing any type of power equipment in an unventilated or material storage shed,

-Care should be taken to rust-proof the equipment. Using a light oil or silicone, coat the equipment, especially cables and all moving parts.

- Be careful not to bend or kink cables.

- If the starter rope becomes disconnected from rope guide on handle, disconnect and ground the spark plug wire, Depress the blade control handle and pull the starter rope out from engine slowly. Slip the starter rope into the rope guide bolt on handle.

Transport

Turn the engine off and allow the engine to cool down. Then disconnect the spark plug wire and empty the fuel tank according to the instructions in the engine manual. Ensure not to bend or damage the cutter when pushing the lawnmower over obstacles.

12. TROUBLESHOOTING

PROBLEM	PROBABLE CAUSE	CORRECTIVE ACTION
Engine does not start.	Fuel tank is empty.	Fill tank with fuel: refer to ENGINE OWNERS MANUAL.
	Air cleaner element is dirty.	Clean air cleaner element: refer to ENGINE OWNERS MANUAL
	Spark plug loose.	Tighten spark plug : refer to ENGINE OWNERS MANUAL
	Spark plug wire loose or disconnected from plug.	Install spark plug wire on spark plug.
	Spark plug gap is incorrect.	Set gap between electrodes: refer to ENGINE OWNERS MANUAL
	Spark plug is defective	Install new, correctly gapped plug: refer to ENGINE OWNERS MANUAL
	Carburetor is flooded with fuel	Remove air cleaner element and pull starter rope continuously until carburetor clears itself and install air cleaner element.
Engine difficult to start or loses power.	Faulty ignition module	Contact the service agent.
	Dirt, water, or stale fuel tank.	Drain fuel and clean tank. Fill tank with clean, fresh fuel
	Vent hole in fuel tank cap is plugged.	Clean or replace fuel tank cap.
Engine operates erratically.	Air cleaner element is dirty.	Clean air cleaner element.
	Spark plug is defective.	Install new, correctly gapped plug: refer to ENGINE OWNERS MANUAL
	Spark plug gap is incorrect.	Set gap between electrodes: refer to ENGINE OWNERS MANUAL
Engine idles poorly.	Air cleaner element is dirty.	Clean air cleaner element: refer to ENGINE OWNERS MANUAL
	Air slots in engine shroud are blocked.	Remove debris from slots.
	Cooling fins and air passages under engine blower housing are blocked.	Remove debris from cooling fins and air passages.
Engine skips at high speed.	Spark plug is defective.	Install new, correctly gapped plug: refer to ENGINE OWNERS MANUAL
Engine overheats	Gap between electrodes of spark plug is too close.	Set gap between electrodes: refer to ENGINE OWNERS MANUAL
	Cooling air flow is restricted.	Remove any debris from slots in shroud, blower housing, air passages
Mower vibrates abnormally	Incorrect spark plug.	Install original spark plug and cooling fins on engine.
	Cutting assembly is loose.	Tighten blade
	Cutting assembly is unbalanced	Balance blade.

13. WARRANTY

This product is warranted in accordance with legal regulations for a 2 year period effective from the date of purchase by the first user.

This warranty covers all material or production failures, it does not include defects from normal wear & tear parts, such as bearings, brushes, cables, plugs or accessories like drills, drill bits, saw blades etc. ;damage or defects resulting from abuse, accidents or alterations; nor the costs for transport.

We reserve the right to reject any claim where the purchase cannot be verified or when it is clear that the product was not maintained properly. (clean ventilation slots, carbon brushes serviced regularly...)

Your purchase receipt must be kept as proof for date of purchase.

Your fully assembled tool must be returned to your dealer in an acceptably clean state, in its original blow molded case if applicable to unit, accompanied by your proof of purchase.

14. DISPOSAL

Should your mower need replacing after extended use, please consult your local laws and regulations to ensure you dispose of mower in the proper and environmentally appropriate way.